

**University of Massachusetts Amherst**

---

**From the Selected Works of Paulina Borrego**

---

Spring March 14, 2019

# Classic Star Wars Patents Coloring Book

Paulina Borrego



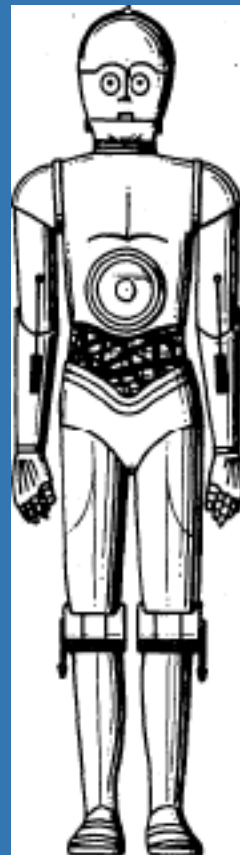
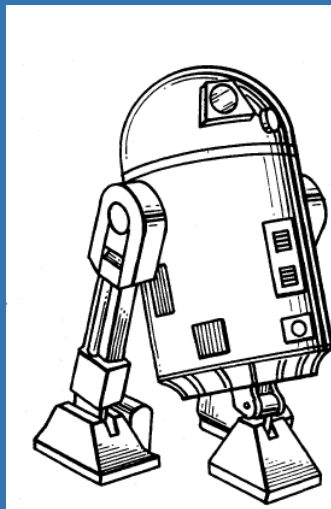
This work is licensed under a [Creative Commons CC\\_BY-NC International License](https://creativecommons.org/licenses/by-nc/4.0/).



Available at: [https://works.bepress.com/paulina\\_borrego/31/](https://works.bepress.com/paulina_borrego/31/)

# *Classic Star Wars Patents*

**Coloring Book**



UMass Amherst Libraries Patent & Trademark Resource Center

March 2019

## Classic Star Wars – March 2019 – Compiled by PTRC Librarian Paulina Borrego

This coloring book contains a patent image from each of the patents or patent applications listed below. While patents or patent applications can be many pages, a single image was chosen for this coloring book.

There are three types of United States patents: Utility patents, Design patents, and Plant patents. The list below contains all design patents.

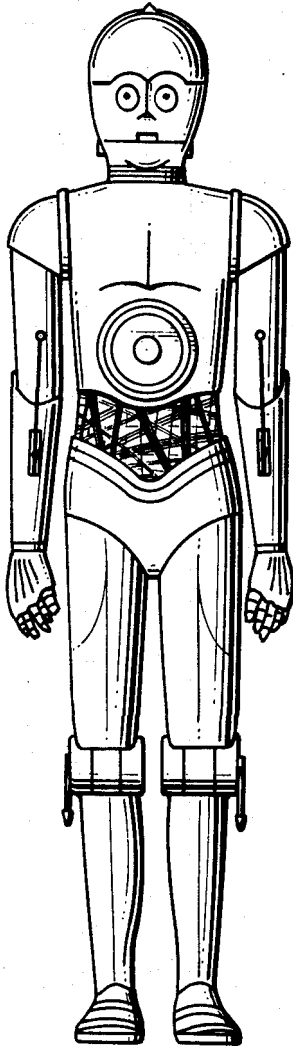
To learn more about patents contact the UMass Amherst Patent & Trademark Resource Center Librarian Paulina Borrego [pborrego@library.umass.edu](mailto:pborrego@library.umass.edu). The UMass Amherst Libraries Patent and Trademark Resource Center (PTRC) is part of a nationwide network of public, state, and academic libraries that are designated by the USPTO (United States Patent and Trademark Office) to disseminate patent and trademark information and to support the diverse intellectual property needs of the public.

This and other patent coloring books available online at [https://works.bepress.com/paulina\\_borrego/](https://works.bepress.com/paulina_borrego/).

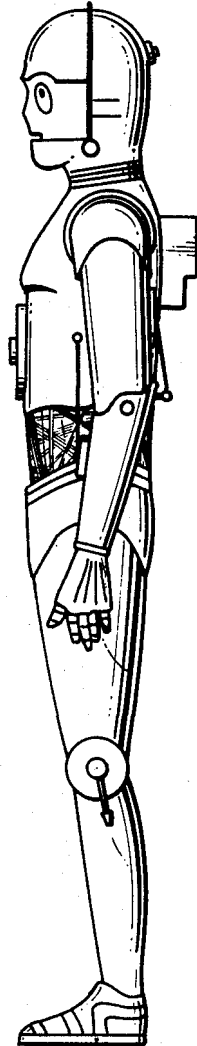
| <b>Patent #</b> | <b>Title of Patent</b> | <b>Issue Date</b>  |
|-----------------|------------------------|--------------------|
| D251,627        | Robot                  | April 17, 1979     |
| D251,628        | Robot                  | April 17, 1979     |
| D254,080        | Toy Spacecraft         | January 29, 1980   |
| D254,081        | Toy Spacecraft         | January 29, 1980   |
| D256,485        | Toy Sword              | August 19, 1980    |
| D257,160        | Aerial Toy             | September 30, 1980 |
| D264,109        | Toy Action Figure      | April 27, 1982     |
| D265,332        | Toy Figure             | July 6, 1982       |
| D265,754        | Toy Figure             | August 10, 1982    |
| D266,777        | Toy Vehicle            | November 2, 1982   |
| D277,116        | Toy Vehicle            | January 8, 1985    |
| D277,201        | Toy Spacecraft         | January 15, 1985   |

Librarians Note: This coloring book does not contain a patent image for the Millennium Falcon because no such U.S. patent or patent application exists contrary to being able to find such an image on the internet. If researched further, one will find that the patent number and issue date on those Millennium Falcon patent images is false.

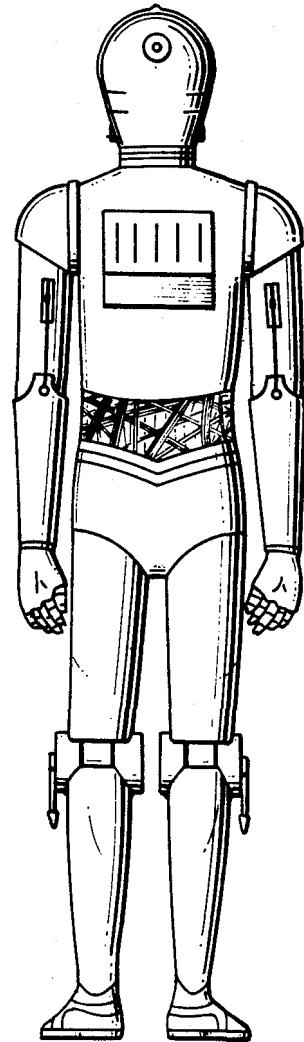
*Fig. 1.*



*Fig. 2.*



*Fig. 3.*



[54] ROBOT

[75] Inventors: **Ralph McQuarrie**, Los Angeles, Calif.; **John Stears**, Gerrards Cross, England

[73] Assignee: **Twentieth Century-Fox Film Corporation**

[\*\*] Term: **14 Years**

[21] Appl. No.: **832,520**

[22] Filed: **Sep. 12, 1977**

[51] Int. Cl. .... **D21-01**

[52] U.S. Cl. .... **D21/150; D21/166**

[58] Field of Search ..... **D34/15 AD, 4 R; 46/149, 46/115, 116, 119, 120**

[56] **References Cited**

**U.S. PATENT DOCUMENTS**

D. 196,443 10/1963 Irwin ..... D34/15 AD

**OTHER PUBLICATIONS**

Playthings, Mar., 1962, p. 363, upper right, "Mr. Atomic."

*Primary Examiner*—Melvin B. Feifer  
*Attorney, Agent, or Firm*—Michael A. Painter

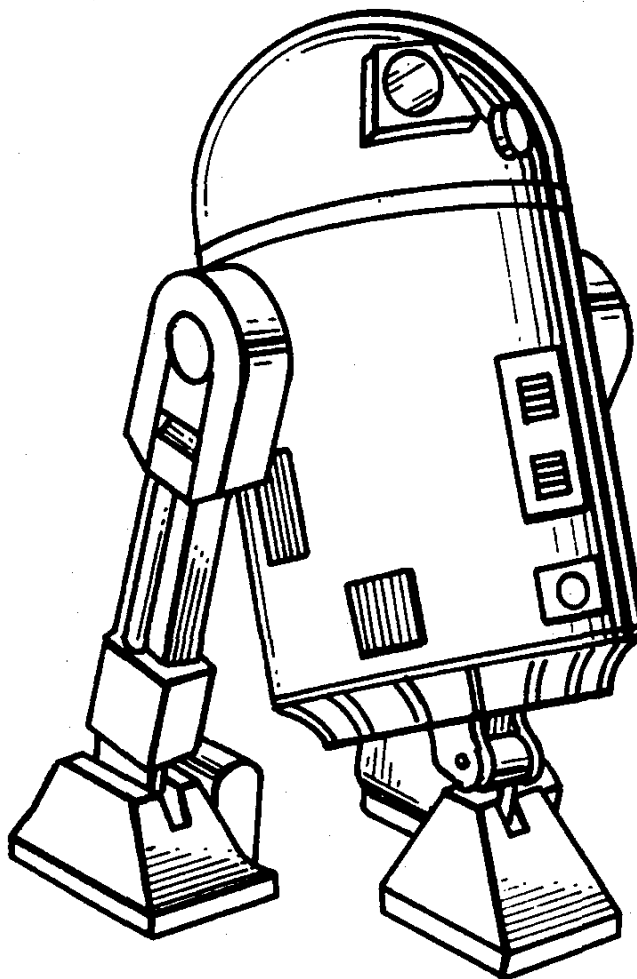
[57] **CLAIM**

The ornamental design for a robot, substantially as shown.

**DESCRIPTION**

FIG. 1 is a front perspective view of a robot showing our new design; and

FIG. 2 is a rear elevation view of the robot shown in FIG. 1.



[54] TOY SPACECRAFT

[75] Inventors: **Joseph Johnston**, North Hollywood;  
**Colin Cantwell**, Newhall, both of Calif.

[73] Assignee: **Twentieth Century-Fox Film Corporation**

[\*\*] Term: **14 Years**

[21] Appl. No.: **832,518**

[22] Filed: **Sep. 12, 1977**

[51] Int. Cl. .... **D21-01**

[52] U.S. Cl. .... **D21/87**

[58] Field of Search ..... **D34/15 HH, 15 HR, 15 PP;**  
**46/74 R, 74 A, 74 D, 53, 58; 272/31 A;**  
**D12/71, 72; D21/87**

[56] **References Cited**

**U.S. PATENT DOCUMENTS**

|            |        |                     |           |
|------------|--------|---------------------|-----------|
| D. 162,790 | 4/1951 | Christman .....     | D34/15 HH |
| D. 178,629 | 9/1956 | Beach .....         | D34/15 HR |
| D. 198,249 | 5/1964 | Sleeman et al. .... | D12/71    |

**OTHER PUBLICATIONS**

Design News, 3-1957, p. 77, Aircraft.

*Primary Examiner*—Joel Stearman

*Assistant Examiner*—Charles A. Rademaker

*Attorney, Agent, or Firm*—Michael A. Painter

[57] **CLAIM**

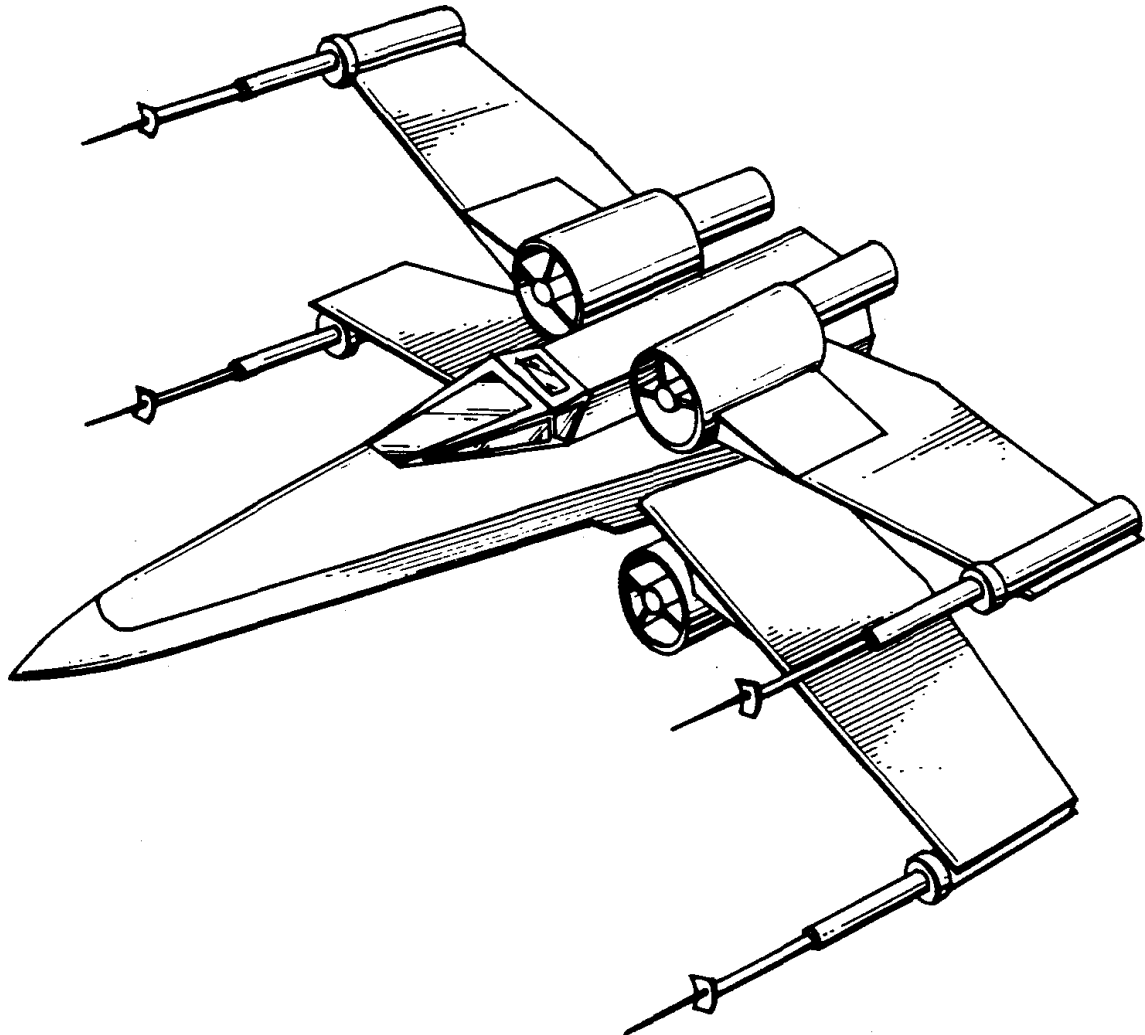
The ornamental design for a toy spacecraft, substantially as shown.

**DESCRIPTION**

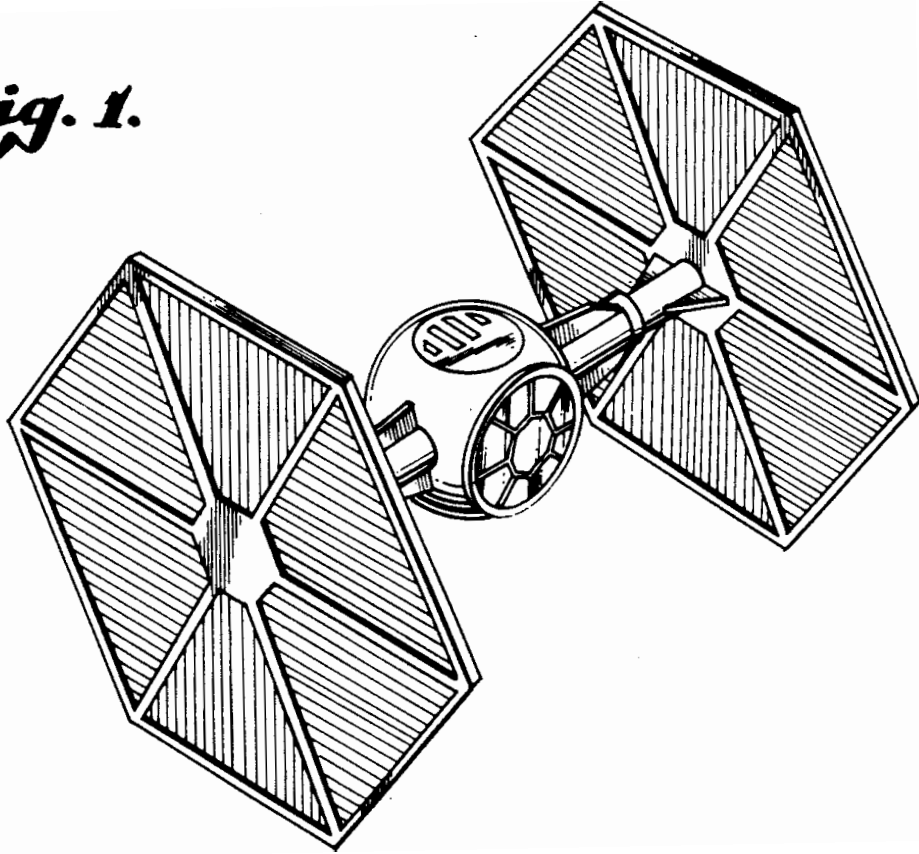
FIG. 1 is a front perspective view of a toy spacecraft showing our new design;

FIG. 2 is a rear perspective view thereof; and,

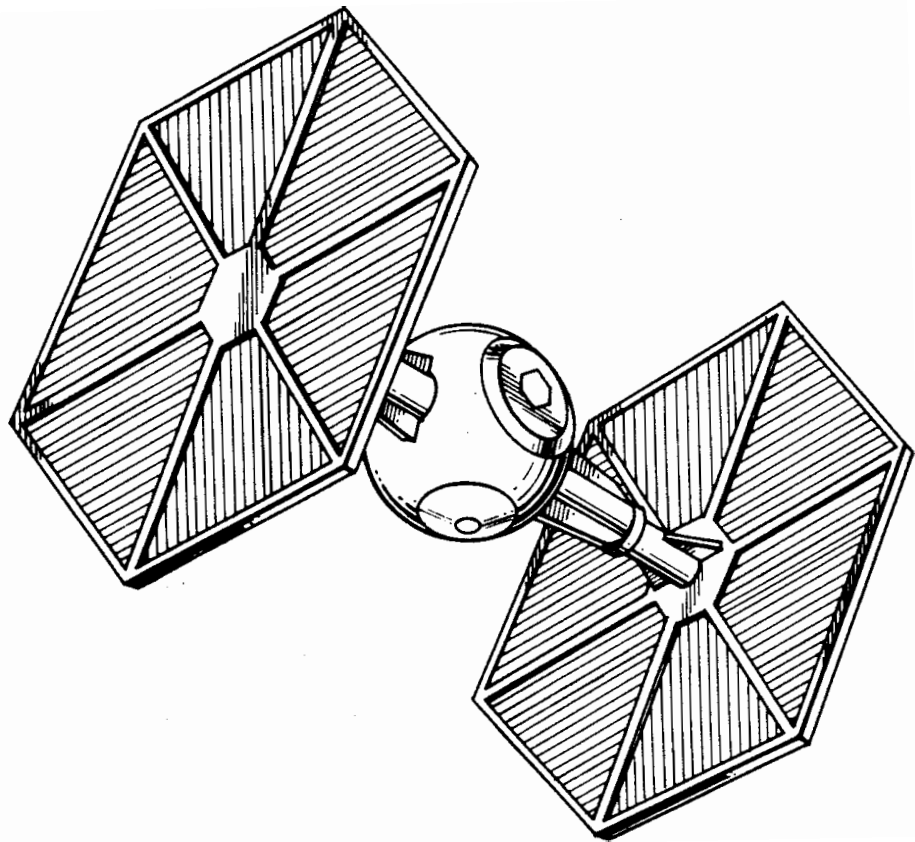
FIG. 3 is a front elevational view thereof.

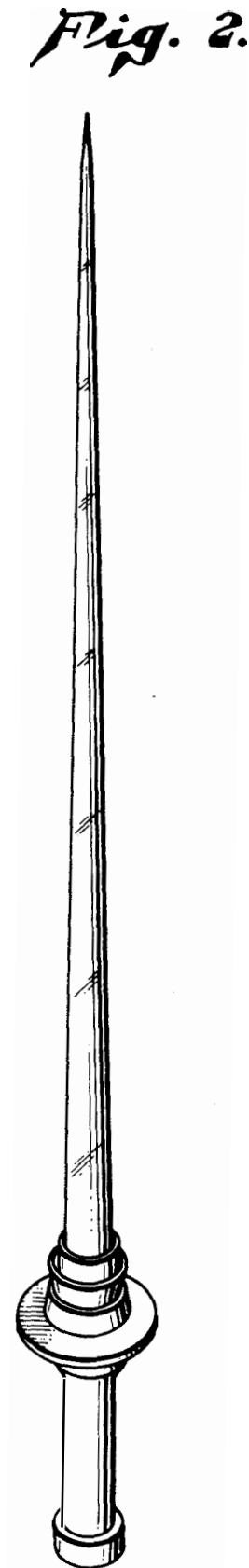
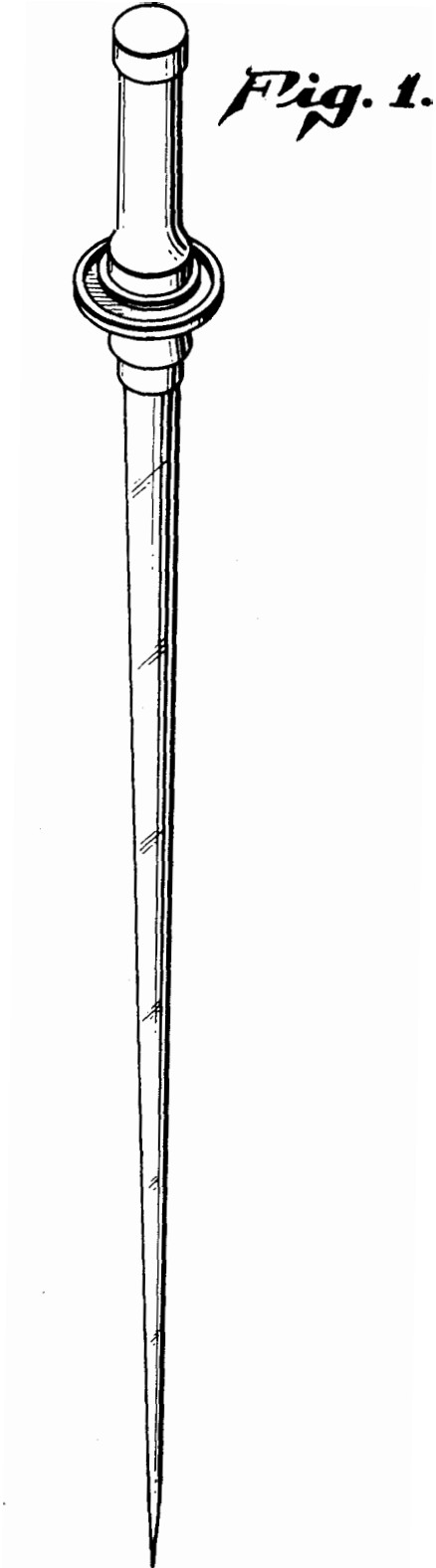


*Fig. 1.*



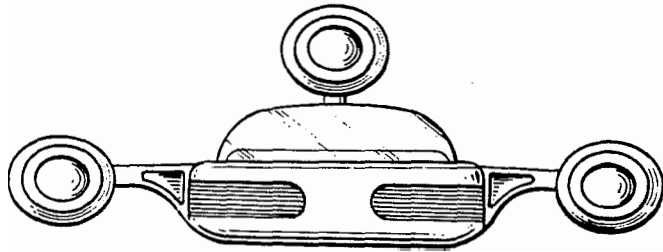
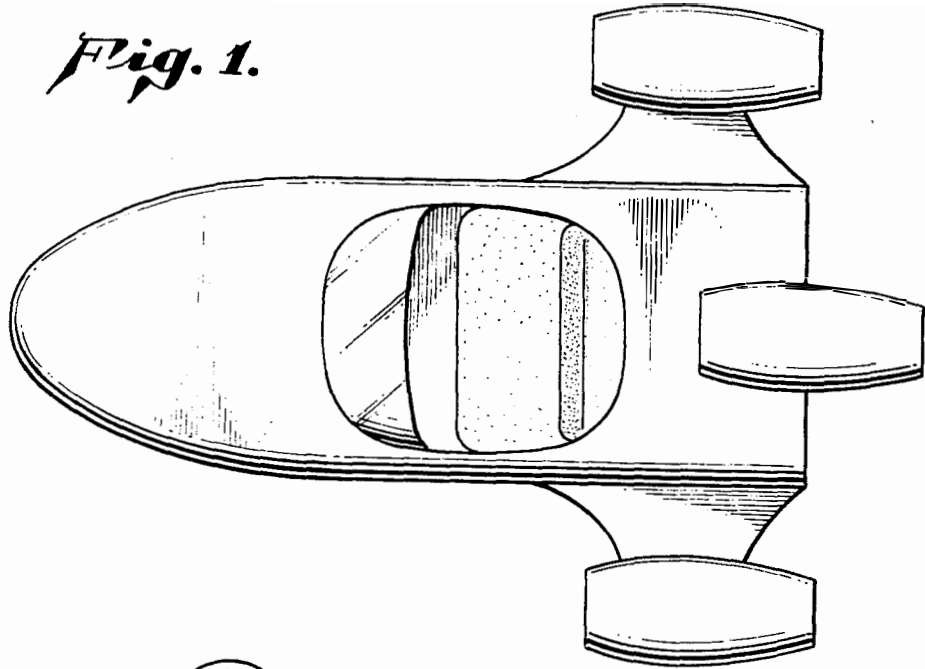
*Fig. 2.*



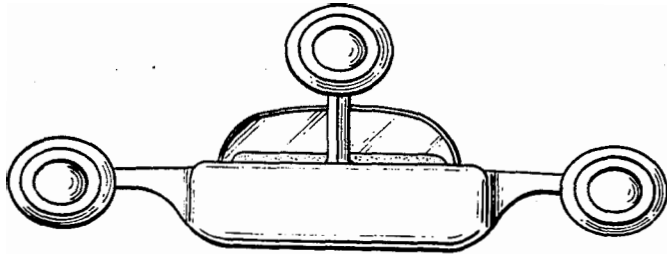




*Fig. 1.*

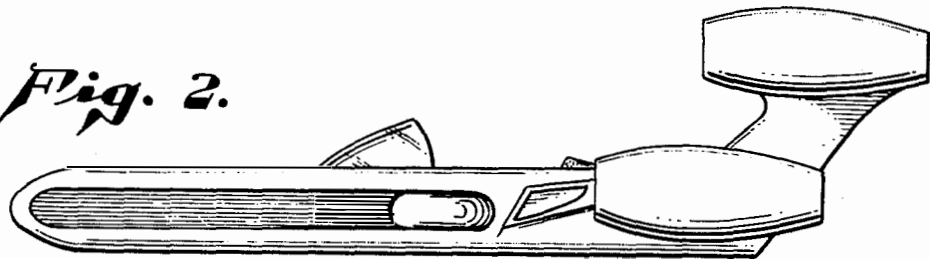


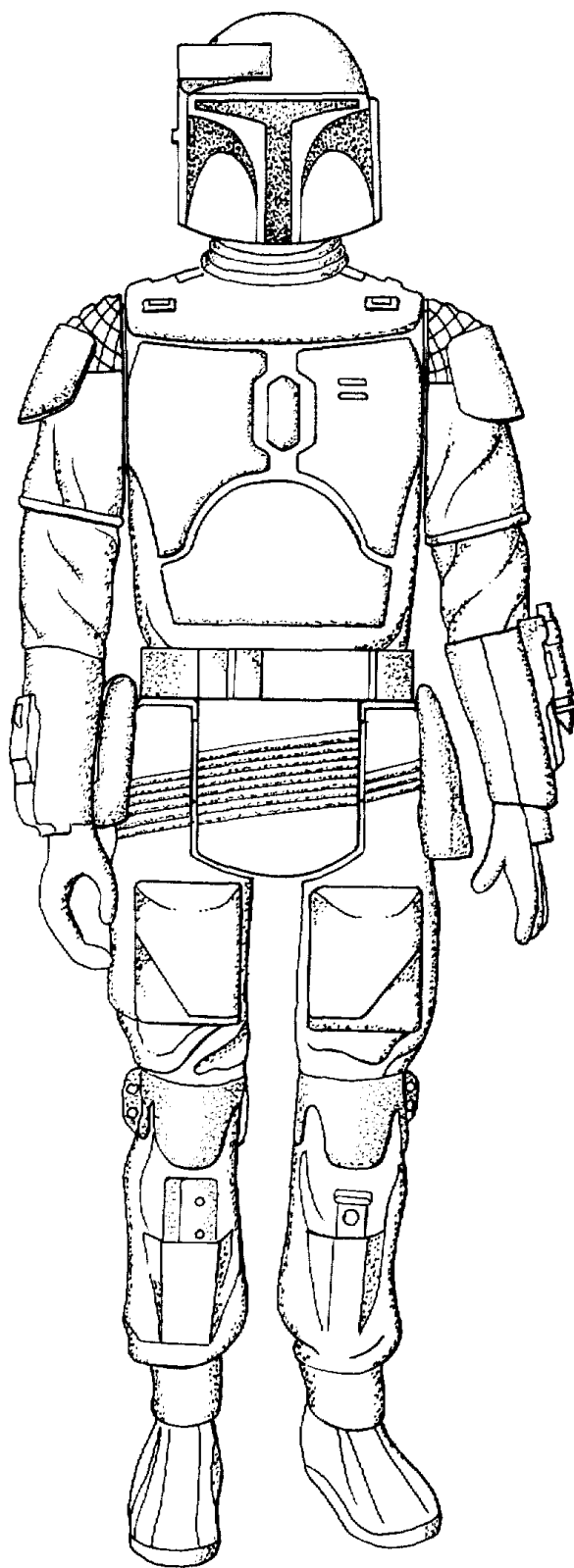
*Fig. 3.*



*Fig. 4.*

*Fig. 2.*





*Fig. 1*

[54] TOY FIGURE

[75] Inventors: **George W. Lucas, Jr.**, San Anselmo;  
**Ralph McQuarrie**, Berkeley; **Joseph E. Johnston**, Fairfax, all of Calif.

[73] Assignee: **Lucasfilm Ltd.**, San Rafael, Calif.

[\*\*] Term: **14 Years**

[21] Appl. No.: **141,462**

[22] Filed: **Apr. 18, 1980**

[51] Int. Cl. .... **D21-01**

[52] U.S. Cl. .... **D21/178; D21/177**

[58] Field of Search ..... **D21/171, 177, 178, 150**

[56]

**References Cited**

**PUBLICATIONS**

FAO Schwartz, Spring-Summer, 1978, p. 13, Star Wars figures, top left figure and bottom right figure.

*Primary Examiner*—Melvin B. Feifer

*Attorney, Agent, or Firm*—Townsend and Townsend

[57]

**CLAIM**

The ornamental design for a toy figure, substantially as shown.

**DESCRIPTION**

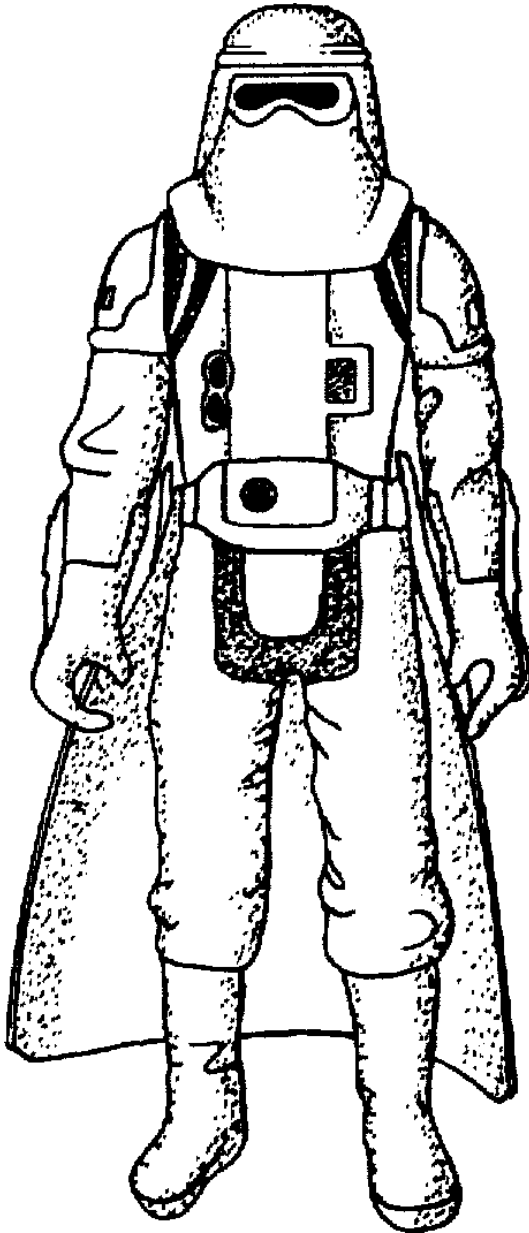
FIG. 1 is a front elevational view of a toy figure illustrating the new design;

FIG. 2 is a left side elevational view thereof;

FIG. 3 is a back side elevational view thereof;

FIG. 4 is a right side elevational view thereof;

FIG. 5 is a top plan view thereof.



[54] TOY FIGURE

[75] Inventors: George W. Lucas, Jr., San Anselmo; Ralph McQuarrie, Berkeley; Joseph E. Johnston, Fairfax, all of Calif.; Stuart Freeborn, Esher, England

[73] Assignee: Lucasfilm, Ltd., San Rafael, Calif.

[\*\*] Term: 14 Years

[21] Appl. No.: 141,597

[22] Filed: Apr. 18, 1980

[51] Int. Cl. .... D21-01

[52] U.S. Cl. .... D21/180; D21/171; D21/186

[58] Field of Search ..... D21/180, 177, 166, 171, D21/186; D11/160

[56] References Cited

U.S. PATENT DOCUMENTS

D. 164,463 9/1951 White ..... D21/186

OTHER PUBLICATIONS

Sears 1978 Xmas Book, p. 574, Illustration No. 13, left figure, Jawa.

Primary Examiner—Melvin B. Feifer  
Attorney, Agent, or Firm—Townsend and Townsend

[57] CLAIM

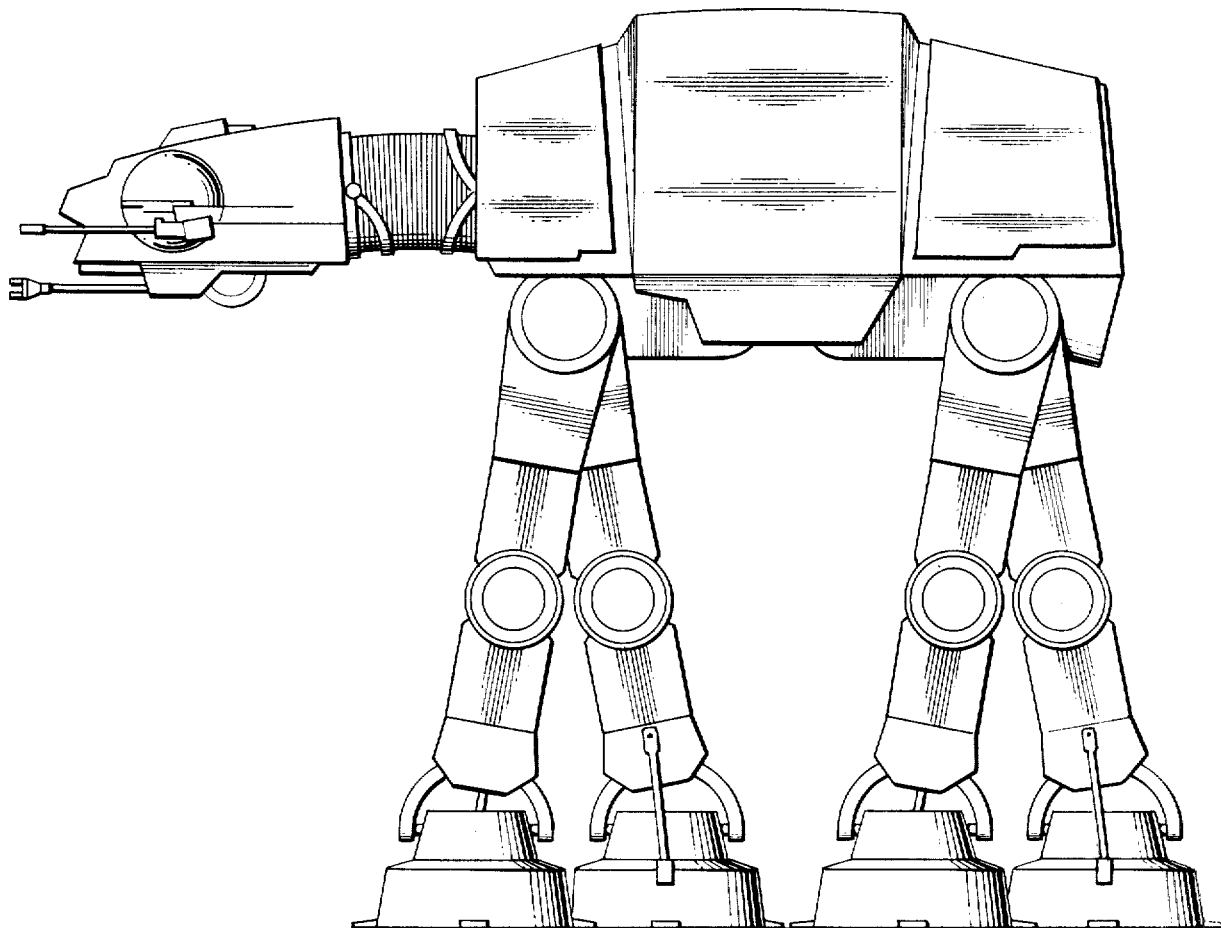
The ornamental design for a toy figure, substantially as shown.

DESCRIPTION

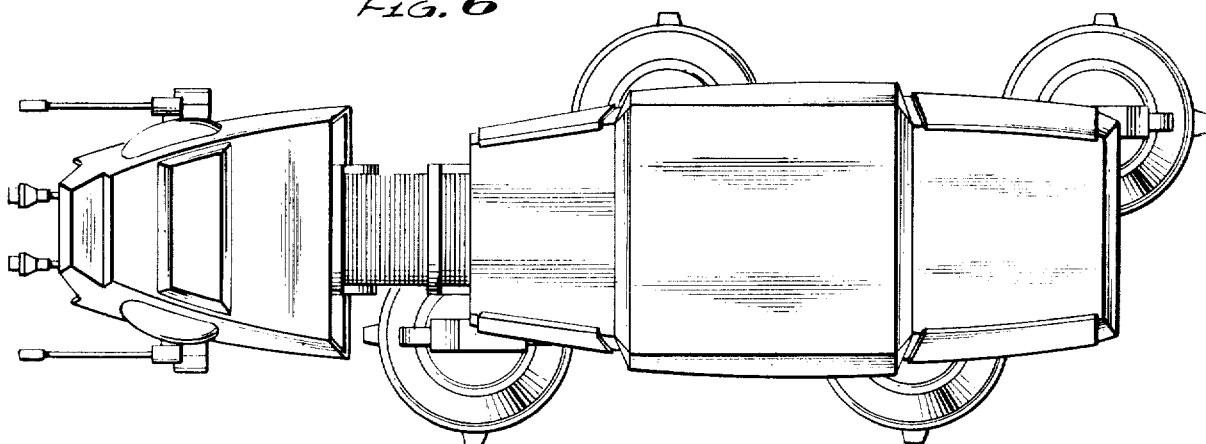
FIG. 1 is a perspective front view of a toy figure illustrating the new design;  
FIG. 2 is a perspective rear view thereof;  
FIG. 3 is a front elevational view thereof;  
FIG. 4 is a left side elevational view thereof;  
FIG. 5 is a right side elevational view thereof;  
FIG. 6 is a rear elevational view thereof;  
FIG. 7 is a top plan view thereof;  
FIG. 8 is a bottom view thereof.



*FIG. 5*



*FIG. 6*



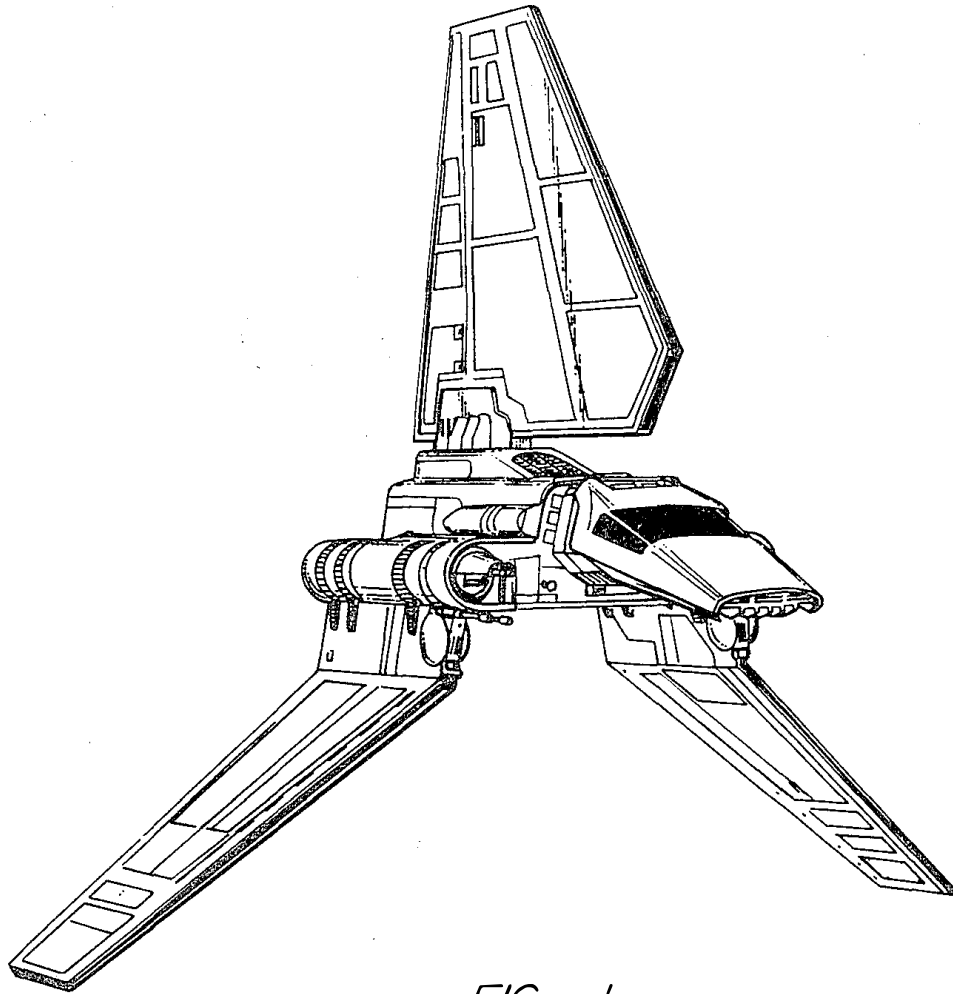


FIG. 1.

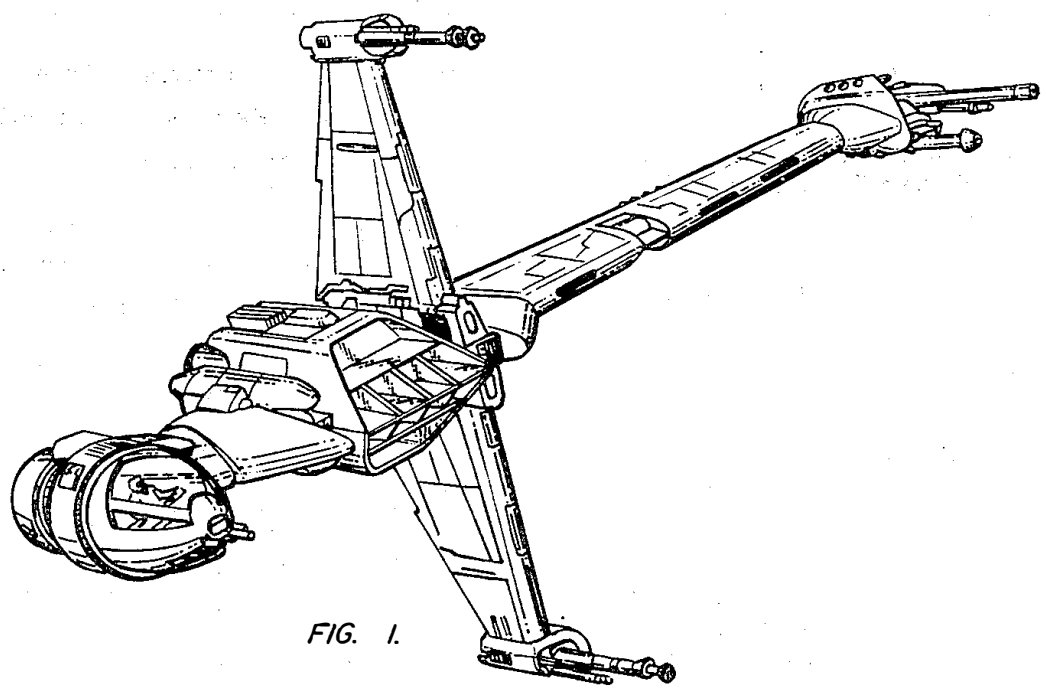


FIG. 1.

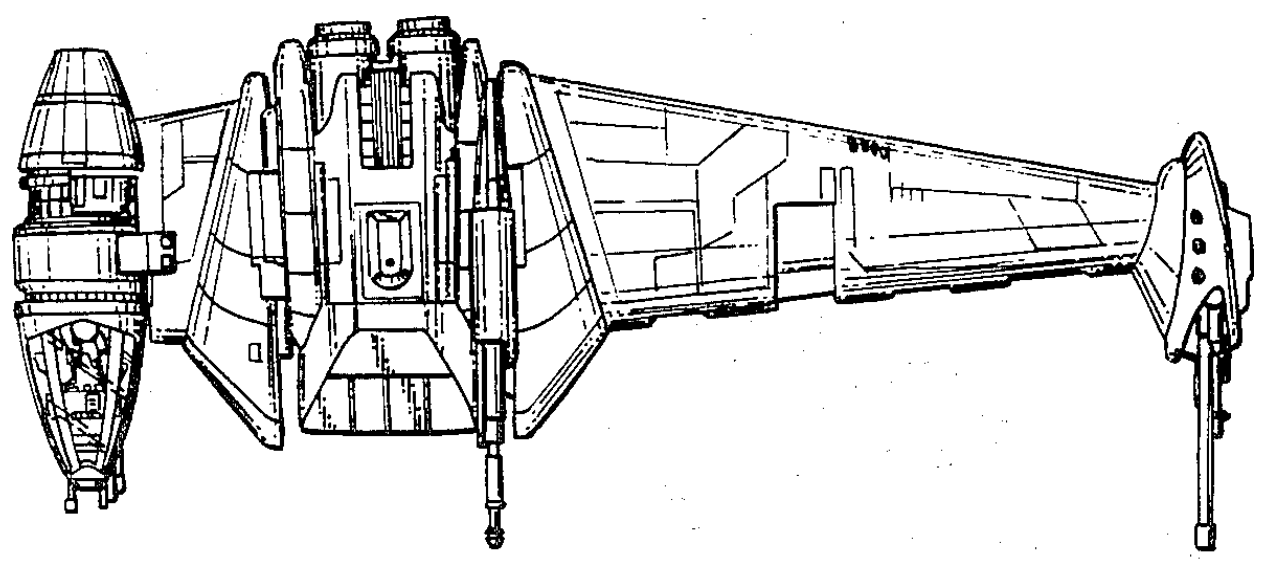


FIG. 2.